

**PR**  
electronics



**5 3 3 1**

**2-проводный  
программируемый  
преобразователь**

№ 5331L115-RU

От серийного №

141365001



**CCOE**



Segurança



**EAC**

**CE**

## Revision Notes

The following list provides notes concerning revisions of this document.

<b>Rev. ID</b>	<b>Date</b>	<b>Notes</b>
113	13/45	IECEX and INMETRO approvals added
114	15/10	PESO/CCOE approval added GOST approval replaced with EAC approval
115	17/07	FM installation drawing updated INMETRO installation drawings updated

# 2-ПРОВОДНЫЙ ПРОГРАММИРУЕМЫЙ ПРЕОБРАЗОВАТЕЛЬ

5331

## Содержание

Области применения .....	2
Техническая характеристика .....	2
Монтаж / установка .....	2
Схемы применений .....	3
Расшифровка кода заказа: 5331.....	4
Электрические данные .....	4
Схемы присоединения.....	8
Принципиальная схема.....	9
Программирование .....	10
Установочные размеры .....	11
Монтаж кабеля датчика.....	11
Приложение.....	12
ATEX Installation Drawing - 5331A .....	13
ATEX Installation Drawing - 5331D .....	14
IECEx Installation Drawing - 5331A.....	16
IECEx Installation Drawing - 5331D.....	17
FM Installation Drawing - 5331D.....	19
CSA Installation Drawing - 5331D .....	21
INMETRO Instruções de Segurança - 5331A.....	22
INMETRO Instruções de Segurança - 5331D.....	23

# 2-ПРОВОДНЫЙ ПРОГРАММИРУЕМЫЙ ИЗМЕРИТЕЛЬНЫЙ ПРЕОБРАЗОВАТЕЛЬ 5331

- *Вход RTD, термопары, линейного сопротивления, mV*
- *Исключительная точность измерения*
- *1,5 kVAC гальванической развязкой*
- *Программируемое значение погрешности датчика*
- *Возможность монтажа в головку датчика по ст. DIN форма B*

## Области применения

- *Линеаризация температуры, измеренной Pt100...Pt1000, Ni100...Ni1000 или термочувствительным элементом.*
- *Преобразование изменения линейного сопротивления в стандартный аналоговый токовый сигнал, напр. от клапанов или омических уровнемеров.*
- *Усиление биполярного mV-сигнала до стандартного токового сигнала 4...20 mA.*

## Техническая характеристика

- *В течение нескольких секунд пользователь может запрограммировать PR5331 на измерение температуры в пределах откалиброванных диапазонов.*
- *Входы RTD и сопротивления имеют компенсацию сопротивления кабеля для 2-, 3- и 4-проводного подключения.*
- *Архивированные данные регулярно подвергаются контролю на сохранность.*

## Монтаж / установка

- *Может монтироваться в корпус датчика по ст. DIN форма B. Во взрывобезопасных зонах измерительный преобразователь 5331 можно монтировать на рейку DIN при помощи специального крепления.*

# СХЕМЫ ПРИМЕНЕНИЙ

RTD к 4...20 мА

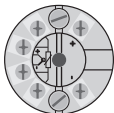
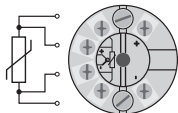

2-проводная установка  
на контрольном пункте



Термопара к 4...20 мА

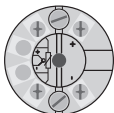
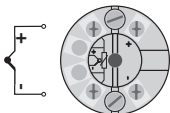

2-проводная установка  
на контрольном пункте

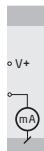

Сопротивление к 4...20 мА

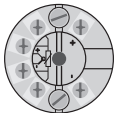
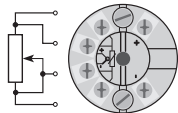

2-проводная установка  
на контрольном пункте

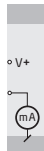

mV к 4...20 мА

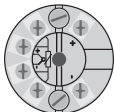
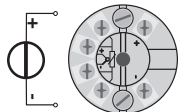

2-проводная установка  
на контрольном пункте

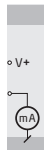

**Расшифровка кода  
заказа: 5331**

Тип	Исполнение	Рабочая температура среды	Гальваническая изоляция
5331	Стандарт : A CSA, FM, ATEX, IECEX и INMETRO : D	-40°C...+85°C : 3	1500 VAC : B

**Электрические данные**

**Диапазон рабочих температур среды:**

От -40°C до +85°C

**Общие данные:**

Напряжение питания, DC

Стандартное исполнение..... 7,2...35 V

CSA, FM, ATEX, IECEX и INMETRO ..... 7,2...30 VDC

Рассеиваемая мощность

Стандартное исполнение..... 25 mW...0,8 W

CSA, FM, ATEX, IECEX & INMETRO..... 25 mW...0,7 W

Падение напряжения..... 7,2 VDC

Изоляция, напряжение тестовое/рабочее 1,5 kVAC / 50 VAC

Время разогрева..... 5 мин.

Интерфейс обмена данными..... Loop Link

Отношение сигнал/шум..... Мин. 60 dB

Время реакции (программируемое)..... 1...60 сек.

Контроль данных в EЕrom..... < 3,5 сек.

Динамический диапазон сигнала, вход..... 20 bit

Динамический диапазон сигнала, выход. 16 bit

Температура калибровки..... 20...28°C

Точность, большее из общих и базовых значений:

Общие значения		
Тип входа	Абс. погрешность	Зависимость от температуры
Все	≤ ±0,05% от диап.	≤ ±0,01% от диап. / °C

Базовые значения		
Тип входа	Основная погрешность	Зависимость от температуры
RTD	$\leq \pm 0,2^{\circ}\text{C}$	$\leq \pm 0,01^{\circ}\text{C}/^{\circ}\text{C}$
Линейное R	$\leq \pm 0,1 \Omega$	$\leq \pm 10 \text{ m}\Omega / ^{\circ}\text{C}$
Напряжение	$\leq \pm 10 \mu\text{V}$	$\leq \pm 1 \mu\text{V} / ^{\circ}\text{C}$
Типы терморпар: E, J, K, L, N, T, U	$\leq \pm 1^{\circ}\text{C}$	$\leq \pm 0,05^{\circ}\text{C} / ^{\circ}\text{C}$
Типы терморпар: B, R, S, W3, W5, LR	$\leq \pm 2^{\circ}\text{C}$	$\leq \pm 0,2^{\circ}\text{C} / ^{\circ}\text{C}$

Зависимость помехоустойчивости по ЭМС.....  $< \pm 0,5\%$  от диап.  
Улучшенная помехоустойчивость по ЭМС:  
NAMUR NE 21, исп. импульсным напр. уровня А  $< \pm 1\%$  от диап.

Реакция на изменение напряжения-

питания.....  $< 0,005\%$  от диап./VDC

Устойчивость к вибрации ..... IEC 60068-2-6 : 2007

2...25 Hz.....  $\pm 1,6 \text{ mm}$

25...100 Hz.....  $\pm 4 \text{ g}$

Макс. сечение проводника..... 1 x 1,5 мм<sup>2</sup> многожильный

Отн. влажность воздуха .....  $< 95\%$  (без конденсата)

Момент затяжки винта клеммы ..... 0,4 Nm

Размеры .....  $\varnothing 44 \times 20,2 \text{ мм}$

Класс защиты (корпус/клемма)..... IP68 / IP00

Вес ..... 50 г

**Электрические данные, вход:**

**Вход RTD и линейного сопротивления:**

Тип	Мин. значение	Макс. значение	Мин. диапазон	Стандарт
Pt100	-200°C	+850°C	25°C	IEC 60751
Ni100	-60°C	+250°C	25°C	DIN 43760
Лин. R	0 Ω	5000 Ω	30 Ω	-----

Макс. смещение нуля (коррекция)..... 50% выбранного макс. значения

Сопротивление кабеля на жилу (макс.)..... 5 Ω

Ток датчика..... Номинальный 2 mA

Влияние сопротивления кабеля датчика  
(3-/4-жильного) .....  $< 0,002 \Omega/\Omega$

Обнаружитель сбоя датчика ..... да

**Вход термодатчик:**

Тип	Мин. температура	Макс. температура	Мин. диап.	Стандарт
B	+400°C	+1820°C	100°C	IEC584
E	-100°C	+1000°C	50°C	IEC584
J	-100°C	+1200°C	50°C	IEC584
K	-180°C	+1372°C	50°C	IEC584
L	-100°C	+900°C	50°C	DIN 43710
N	-180°C	+1300°C	50°C	IEC584
R	-50°C	+1760°C	100°C	IEC584
S	-50°C	+1760°C	100°C	IEC584
T	-200°C	+400°C	50°C	IEC584
U	-200°C	+600°C	50°C	DIN 43710
W3	0°C	+2300°C	100°C	ASTM E988-90
W5	0°C	+2300°C	100°C	ASTM E988-90
LR	-200°C	+800°C	50°C	GOST 3044-84

Макс. смещение нуля (коррекция) ..... 50% от выбранного макс. значения

Компенсация холодного спая (CJC) ..... < ±1,0°C

Обнаружение сбоя датчика ..... да

Ток обнаружения сбоя датчика:

    в процессе обнаружения ..... номинальный 33 µA

    иначе ..... 0 µA

**Вход напряжения:**

Диапазон измерения..... -12...800 mV

Мин. диапазон измерения (шкала) ..... 5 mV

Макс. смещение нуля (коррекция) ..... 50% от выбранного макс. значения

Входное сопротивление..... 10 MΩ

**Выход:****Токовый выход:**

Диапазон сигнала ..... 4...20 mA

Мин. диапазон сигнала..... 16 mA

Время актуализации..... 440 мс

Выходной сигнал при сбое EEPROM ..... ≤ 3,5 mA

Сопротивление нагрузки ..... ≤ (Vпитания - 7,2) / 0,023 [Ω]

Стабильность нагрузки..... < ±0,01% от диап./ 100 Ω

**Обнаружение сбоя датчика:**

Программируемое ..... 3,5...23 mA

NAMUR NE43 вверх ..... 23 mA

NAMUR NE43 вниз..... 3,5 mA

**От диап.** = от актуально выбранного диапазона



**Сертификаты:**

EMC .....	2014/30/EU
CCOE .....	P337392/1
RoHS .....	2011/65/EU
EAC .....	TP TC 020/2011

**Одобрение для применения на судах и платформах:**

DNV-GL, Правила для судов..... Стандарт сертиф. №. 2.4

**Сертификация по Ex / I.S.**

ATEX 2014/34/EU

5331A .....	KEMA 10ATEX0002 X
5331D .....	KEMA 06ATEX0062 X
FM .....	FM17US0013X
CSA .....	1125003
IECEx .....	DEK 13.0035X
INMETRO .....	DEKRA 16.0013 X
CCOE .....	P337392/2
EAC Ex TP TC 012/2011 .....	RU C-ДК.ГБ08.В.00410

# СХЕМЫ ПРИСОЕДИНЕНИЯ

## Вход:

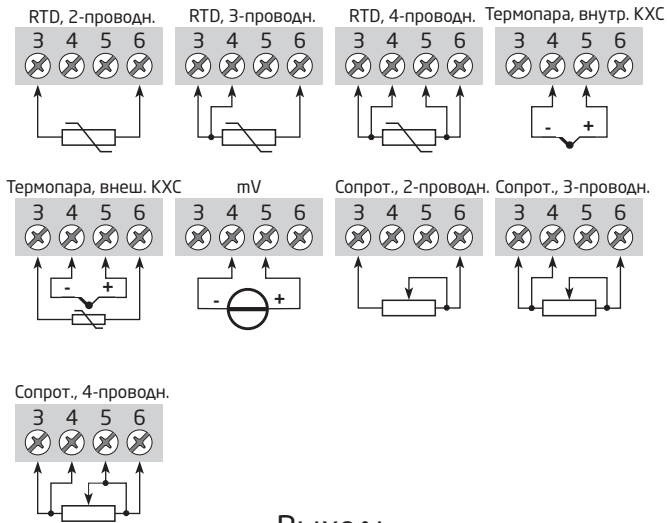

## Выход:

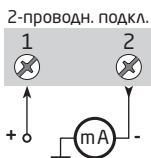

# ПРИНЦИПИАЛЬНАЯ СХЕМА

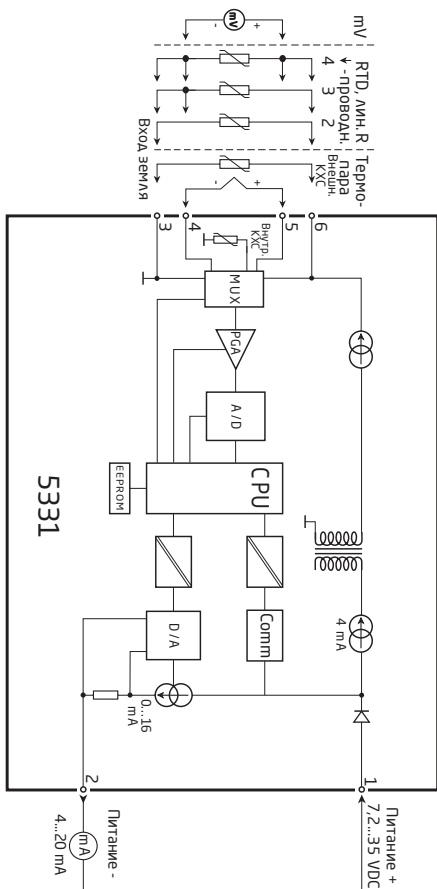

# ПРОГРАММИРОВАНИЕ

- Loop Link представляет собой питаемый от батареи интерфейс обмена данными, необходимый для программирования 5331.
- О процедуре программирования см. илл. ниже и справочно-информационную функцию в ПО PReset.
- Loop Link нельзя использовать для связи с модулями, установленными во взрывоопасной (Ex) зоне.

Наименование при заказе: Loop Link

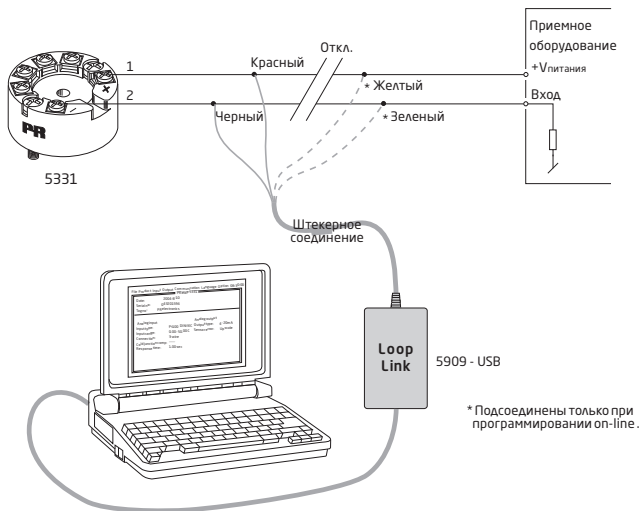

## Установочные размеры

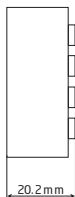
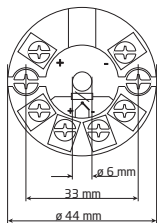

## Монтаж кабеля датчика

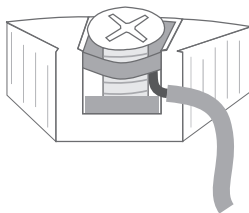

Провод монтируют между пластинами

# ПРИЛОЖЕНИЕ

**ATEX Installation Drawing - 5331A**

**ATEX Installation Drawing - 5331D**

**IECEX installation drawing - 5331A**

**IECEX installation drawing - 5331D**

**FM Installation Drawing - 5331D**

**CSA Installation Drawing - 5331D**

**INMETRO Instruções de Segurança - 5331A**

**INMETRO Instruções de Segurança - 5331D**

## ATEX Installation drawing

For safe installation of 5331A3B or 5334A3B the following must be observed. The module shall only be installed by qualified personnel who are familiar with the national and international laws, directives and standards that apply to this area.

Year of manufacture can be taken from the first two digits in the serial number.

ATEX Certificate      KEMA 10ATEX 0002 X

Marking  II 3 G Ex nA [ic] IIC T4 ... T6 Gc  
II 3 G Ex ic IIC T4...T6 Gc  
II 3 D Ex ic IIIC Dc

Standards              EN 60079-0 : 2012, EN 60079-11 : 2012, EN 60079-15 : 2010

T4:  $-40 \leq T_a \leq 85^\circ\text{C}$   
T6:  $-40 \leq T_a \leq 60^\circ\text{C}$

**Terminal: 3,4,5,6**  
Ex nA [ic]

U<sub>o</sub>: 9.6 V  
I<sub>o</sub>: 25 mA  
P<sub>o</sub>: 60 mW  
L<sub>o</sub>: 33 mH  
C<sub>o</sub>: 2.4  $\mu\text{F}$

**Terminal: 1,2**  
Ex nA

U<sub>max</sub>  $\leq$  35 VDC

**Terminal: 1,2**  
Ex ic

U<sub>i</sub> = 35 VDC  
I<sub>i</sub> = 110 mA  
L<sub>i</sub> = 10  $\mu\text{H}$   
C<sub>i</sub> = 1.0 nF

### Special conditions for safe use.

For type of protection Ex nA, the transmitter shall be mounted in a metal enclosure providing a degree of protection of at least IP54 according to EN60529.

For use in the presence of combustible dusts the transmitter shall be mounted in an enclosure providing a degree of protection of at least IP6X in accordance with EN60529, the surface temperature of the outer enclosure is 20 K above the ambient temperature.

For an ambient temperature  $\geq 60^\circ\text{C}$ , heat resistant cables shall be used with a rating of at least 20 K above the ambient temperature.

## ATEX Installation drawing



For safe installation of 5331D or 5334B the following must be observed. The module shall only be installed by qualified personnel who are familiar with the national and international laws, directives and standards that apply to this area.

Year of manufacture can be taken from the first two digits in the serial number.

ATEX Certificate      KEMA 06ATEX 0062 X

Marking



II 1 G Ex ia IIC T4...T6 Ga  
II 1 D Ex ia IIIC Da  
I M1 Ex ia I Ma

Standards            EN 60079-0 : 2012, EN 60079-11 : 2012, EN 60079-26 : 2007,  
EN 60079-15 :2010

Hazardous area  
Zone 0, 1, 2, 20, 21, 22

T4:  $-40 \leq T_a \leq 85^\circ\text{C}$

T6:  $-40 \leq T_a \leq 60^\circ\text{C}$

**Terminal: 3,4,5,6**

Uo: 9.6 VDC

Io: 25 mA

Po: 60 mW

Lo: 33 mH

Co: 2.4 $\mu$ F

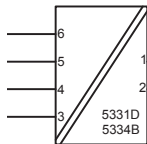

**Terminal: 1,2**

Ui: 30 VDC

Ii: 120 mA

Pi: 0.84 W

Li: 10  $\mu$ H

Ci: 1.0 nF

Non Hazardous Area

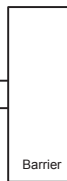



**Installation notes.**

The sensor circuit is not infallibly galvanic isolated from the input circuit. However, the galvanic isolation between the circuits is capable of withstanding a test voltage of 500Vac during 1 minute.

In a potentially explosive gas atmosphere, the transmitter shall be mounted in an enclosure in order to provide a degree of protection of at least IP20 according to EN60529.

If the transmitter is installed in an explosive atmosphere requiring the use of equipment of category 1 G, 1 M or 2 M, and if the enclosure is made of aluminum, it must be installed such that ignition sources due to impact and friction sparks are excluded.

If the enclosure is made of non-metallic materials, electrostatic charging shall be avoided.

For installation in a potentially explosive dust atmosphere, the following instructions apply:

The transmitter shall be mounted in a metal enclosure form B according to DIN43729 that is providing a degree of protection of at least IP6X according to EN60529, that is suitable for the application and correctly installed.

Cable entries and blanking elements shall be used that are suitable for the application and correctly installed.

For an ambient temperature  $\geq 60^{\circ}\text{C}$ , heat resistant cables shall be used with a rating of at least 20 K above the ambient temperature.

The surface temperature of the enclosure is equal to the ambient temperature plus 20 K, for a dust layer with a thickness up to 5 mm

## IECEx Installation drawing



For safe installation of 5331A or 5334A the following must be observed. The module shall only be installed by qualified personnel who are familiar with the national and international laws, directives and standards that apply to this area.  
Year of manufacture can be taken from the first two digits in the serial number.

Certificate	IECEx DEK 13.0035X
Marking	Ex nA [ic] IIC T4..T6 Gc Ex ic IIC T4..T6 Gc Ex ic IIIC Dc
Standards	IEC 60079-0 : 2011, IEC 60079-11 : 2011, IEC 60079-15 : 2010

T4: $-40 \leq T_a \leq 85^\circ\text{C}$	<b>Terminal: 3,4,5,6</b>	<b>Terminal: 1,2</b>	<b>Terminal: 1,2</b>
T6: $-40 \leq T_a \leq 60^\circ\text{C}$	Uo: 9.6 V	Ex nA	Ex ic
	Io: 25 mA		
	Po: 60 mW	Umax =35 VDC	Ui = 35 VDC
	Lo: 33 mH		Ii = 110mA
	Co: 2.4 $\mu\text{F}$		Li = 10 $\mu\text{H}$
			Ci = 1.0 nF

### Installation note:

For installation in a potentially explosive gas atmosphere, the following instructions apply:  
For nA installation the transmitter must be installed in a metal enclosure, e.g. a form B enclosure providing a degree of protection of at least IP54 according to IEC60529 or in an enclosure with type of protection Ex n or Ex e.

For ic installation the transmitter must be installed in enclosure providing a degree of protection of at least IP20 according to IEC60529 and that is suitable for the application.

Cable entry devices and blanking elements shall fulfill the same requirements  
For an ambient temperature  $\geq 60^\circ\text{C}$ , heat resistant cables shall be used with a rating of at least 20 K above the ambient temperature.

For installation in a potentially explosive dust atmosphere, the following instructions apply:  
The surface temperature of the enclosure is equal to the ambient temperature plus 20 K, for a dust layer with a thickness up to 5 mm.  
The transmitter must be mounted in a enclosure according to DIN 43729 that provides a degree of protection of at least IP6X according to IEC60529, and that is suitable for the application. Cable entry devices and blanking elements shall fulfill the same requirements.

## IECEx Installation drawing



For safe installation of 5331D or 5334B the following must be observed. The module shall only be installed by qualified personnel who are familiar with the national and international laws, directives and standards that apply to this area.

Year of manufacture can be taken from the first two digits in the serial number.

Certificate	IECEx DEK 13.0035X
Marking	Ex ia IIC T4...T6 Ga Ex ia IIIC Da Ex ia I Ma
Standards	IEC 60079-0 : 2011, IEC 60079-11 : 2011, IEC 60079-26:2006

### Hazardous area

Zone 0, 1, 2, 20, 21, 22, M1

T4:  $-40 \leq T_a \leq 85^\circ\text{C}$

T5:  $-40 \leq T_a \leq 60^\circ\text{C}$

T6:  $-40 \leq T_a \leq 45^\circ\text{C}$

### Terminal: 3,4,5,6

U<sub>o</sub>: 9.6 VDC

I<sub>o</sub>: 25 mA

P<sub>o</sub>: 60 mW

L<sub>o</sub>: 33 mH

C<sub>o</sub>: 2.4  $\mu\text{F}$

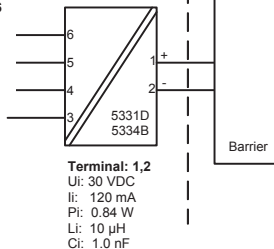

**Installation notes.**

The sensor circuit is not infallibly galvanic isolated from the input circuit. However, the galvanic isolation between the circuits is capable of withstanding a test voltage of 500Vac during 1 minute.

In a potentially explosive gas atmosphere, the transmitter shall be mounted in a metal form B enclosure in order to provide a degree of protection of at least IP20 according to IEC60529. If however the environment requires a higher degree of protection, this shall be taken into account.

If the transmitter is installed in an explosive atmosphere requiring the use of equipment protection level Ga, Ma and Mb, and if the enclosure is made of aluminum, it must be installed such, that ignition sources due to impact and friction sparks are excluded.

For installation in a potentially explosive dust atmosphere, the following instructions apply:

For explosive dust atmospheres, the surface temperature of the outer enclosure is 20 K above the ambient temperature.

The transmitter shall be mounted in a metal enclosure form B according to DIN43729 that is providing a degree of protection of at least IP6X according to IEC60529, that is suitable for the application and correctly installed.

Cable entries and blanking elements shall be used that are suitable for the application and correctly installed.

For an ambient temperature  $\geq 60^{\circ}\text{C}$ , heat resistant cables shall be used with a rating of at least 20 K above the ambient temperature.

## FM Installation Drawing

### Model 5331D, 5333D and 5343B

#### Hazardous (Classified) Location

Class I, Division 1, Groups, A, B, C, D T4..T6  
Class I, Zone 0, AEx ia IIC T4..T6

Ambient temperature limits  
T4: -40 to +85 deg. Celsius  
T6: -40 to +60 deg. Celsius

Terminal 1, 2  
Vmax or Ui: 30 V  
Imax or Ii: 120 mA  
Pmax or Pi: 0.84 W  
Ci: 1 nF  
Li: 10 uH

Terminal 3,4,5,6  
Vt or Uo: 9.6 V  
It or Io: 28 mA  
Pt or Po: 67.2 mW  
Ca or Co: 3.5 uF  
La or Lo: 35 mH

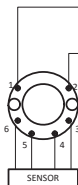

#### Non Hazardous Location

Associated Apparatus  
or Barrier  
with  
entity Parameters:

$UM \leq 250V$   
 $Voc \text{ or } Uo \leq Vmax \text{ or } Ui$   
 $Isc \text{ or } Io \leq Imax \text{ or } Ii$   
 $Po \leq Pi$   
 $Ca \text{ or } Co \geq Ci + Ccable$   
 $La \text{ or } Lo \geq Li + Lcable$

This device must not be connected  
to any associated apparatus which  
uses or generates more than 250  
VRMS

### Model 5335D, 5337D

#### Hazardous (Classified) Location

Class I, Division 1, Groups, A, B, C, D T4..T6  
Class I, Zone 0, AEx ia IIC T4..T6

Ambient temperature limits  
T4: -40 to +85 deg. Celsius  
T6: -40 to +60 deg. Celsius

Terminal 1, 2  
Vmax or Ui: 30 V  
Imax or Ii: 120 mA  
Pmax or Pi: 0.84 W  
Ci: 1 nF  
Li: 10 uH

Terminal 3,4,5,6  
Vt or Uo: 9.6 V  
It or Io: 28 mA  
Pt or Po: 67.2 mW  
Ca or Co: 3.5 uF  
La or Lo: 35 mH

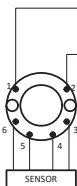

#### Non Hazardous Location

Associated Apparatus  
or Barrier  
with  
entity Parameters:

$UM \leq 250V$   
 $Voc \text{ or } Uo \leq Vmax \text{ or } Ui$   
 $Isc \text{ or } Io \leq Imax \text{ or } Ii$   
 $Po \leq Pi$   
 $Ca \text{ or } Co \geq Ci + Ccable$   
 $La \text{ or } Lo \geq Li + Lcable$

This device must not be connected  
to any associated apparatus which  
uses or generates more than 250  
VRMS

### The entity concept

The Transmitter must be installed according to National Electrical Code (ANSI-NFPA 70) and shall be installed with the enclosure, mounting, and spacing segregation requirement of the ultimate application.

Equipment that is FM-approved for intrinsic safety may be connected to barriers based on the ENTITY CONCEPT. This concept permits interconnection of approved transmitters, meters and other devices in combinations which have not been specifically examined by FM, provided that the agency's criteria are met. The combination is then intrinsically safe, if the entity concept is acceptable to the authority having jurisdiction over the installation.

The entity concept criteria are as follows:

The intrinsically safe devices, other than barriers, must not be a source of power.

The maximum voltage  $U_i(V_{MAX})$  and current  $I_i(I_{MAX})$ , and maximum power  $P_i(P_{MAX})$ , which the device can receive and remain intrinsically safe, must be equal to or greater than the voltage ( $U_o$  or  $V_{OC}$  or  $V_i$ ) and current ( $I_o$  or  $I_{SC}$  or  $I_i$ ) and the power  $P_o$  which can be delivered by the barrier.

The sum of the maximum unprotected capacitance ( $C_i$ ) for each intrinsically device and the interconnecting wiring must be less than the capacitance ( $C_a$ ) which can be safely connected to the barrier.

The sum of the maximum unprotected inductance ( $L_i$ ) for each intrinsically device and the interconnecting wiring must be less than the inductance ( $L_a$ ) which can be safely connected to the barrier.

The entity parameters  $U_o, V_{OC}$  or  $V_i$  and  $I_o, I_{SC}$  or  $I_i$ , and  $C_a$  and  $L_a$  for barriers are provided by the barrier manufacturer.

### NI Field Circuit Parameters

### Model 5331D, 5333D, 5335D, 5337D and 5343B

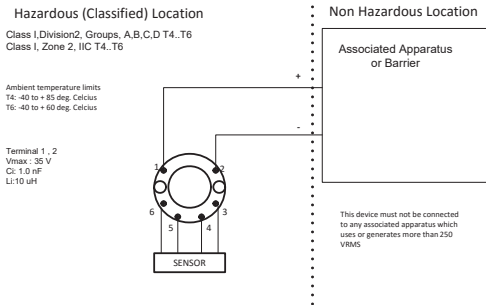

## CSA Installation drawing 533XQC03

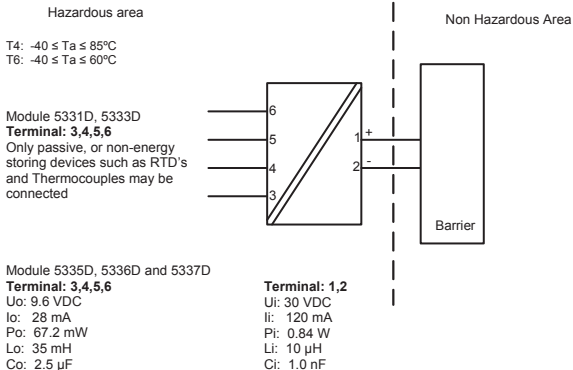

CLASS 2258 04 - PROCESS CONTROL EQUIPMENT - Intrinsically Safe Entity - For Hazardous Locations  
Class I, Division 1, Groups A, B, C and D  
Ex ia IIC, Ga

CLASS 2258 84 - PROCESS CONTROL EQUIPMENT - Intrinsically Safe Entity - For Hazardous Locations - Certified to US Standards  
Class I, Division 1, Groups A, B, C and D  
Class I, Zone 0, AEx ia IIC, Ga

**Warning:**

Substitution of components may impair intrinsic safety.

The transmitters must be installed in a suitable enclosure to meet installation codes stipulated in the Canadian Electrical Code (CEC) or for US the National Electrical Code (NEC).

## Desenho de Instalação INMETRO



Para instalação segura do 5331A ou 5334A o seguinte deve ser observado. O modelo deve apenas ser instalado por pessoas qualificadas que são familiarizadas com as leis nacionais e internacionais, diretrizes e padrões que se aplicam a esta área.

O ano de fabricação pode ser pego dos dois primeiros dígitos do número de série.

Certificado DEKRA 16.0013 X

Marcas Ex nA [ic] IIC T4..T6 Gc  
Ex ic IIC T4..T6 Gc  
Ex ic IIC Dc

Normas ABNT NBR IEC 60079-0 : 2013; ABNT NBR IEC 60079-11 : 2013  
ABNT NBR IEC60079-15 : 2012

T4:  $-40 \leq T_a \leq 85^\circ\text{C}$   
T6:  $-40 \leq T_a \leq 60^\circ\text{C}$

### Terminais:

**3,4,5,6**  
Uo: 9,6 V  
Io: 25 mA  
Po: 60 mW  
Lo: 33 mH  
Co: 2,4  $\mu\text{F}$

### Terminais: 1,2

Ex nA  
U  $\leq 35$  VDC

### Terminais: 1,2

Ex ic  
Ui = 35 VDC  
Ii = 110 mA  
Li = 10  $\mu\text{H}$   
Ci = 1,0 nF

### Notas para instalação

Para a instalação em uma atmosfera de gás potencialmente explosivo, aplicam-se as instruções a seguir:

Para a instalação nA o transmissor deve ser instalado em um invólucro de metal, por exemplo, gabinete em forma B que forneça um grau de proteção de pelo menos IP54 de acordo com ABNT NBR IEC60529 ou em um invólucro com tipo de proteção Ex n ou Ex e.

Para a instalação Ex ic o transmissor deve ser instalado em um invólucro proporcionando um grau de proteção IP20 de acordo com a norma ABNT NBR IEC60529. E o invólucro deve, pelo menos, ser adequado para a aplicação e corretamente instalado.

Dispositivos de entrada de cabos e elementos de supressão devem cumprir os mesmos requisitos.

Para temperatura ambiente  $\geq 60^\circ\text{C}$ , fios de resistência ao calor devem ser usados com uma faixa de pelo menos 20K acima da temperatura ambiente.

Para a instalação em uma atmosfera de poeira potencialmente explosiva, aplicam-se as instruções a seguir:

O transmissor deve ser montado em invólucro de metal forma B de acordo com DIN43729 que está fornecendo pelo menos um grau de proteção IP6X de acordo com ABNT NBR IEC60529.

O invólucro deve ser adequado para aplicação e instalado corretamente.

As entradas dos cabos e os elementos de obtenção que podem ser utilizados devem ser adequados à aplicação pretendida e corretamente instalados.

A temperatura da superfície do invólucro é igual à temperatura ambiente mais 20 K, para uma camada de pó, com uma espessura de até 5 mm.



## Desenho de Instalação INMETRO



Para instalação segura do 5331D ou 5334B o seguinte deve ser observado. O modelo deve apenas ser instalado por pessoas qualificadas que são familiarizadas com as leis nacionais e internacionais, diretrizes e padrões que se aplicam a esta área.  
O ano de fabricação pode ser pego dos dois primeiros dígitos do número de série.

Certificado .....DEKRA 16.0013 X

Marcas                    Ex ia IIC T6...T4 Ga  
                                 Ex ia IIIC Da

Normas   ABNT NBR IEC 60079-0: 2013; ABNT NBR IEC 60079-11: 2013

Áreas classificadas

Zona 0, 1, 2, 20, 21, 22,

T4:  $-40 \leq T_a \leq 85^{\circ}\text{C}$

T5:  $-40 \leq T_a \leq 60^{\circ}\text{C}$

T6:  $-40 \leq T_a \leq 45^{\circ}\text{C}$

**Terminais 3,4,5,6**

Uo: 9,6 VDC

Io: 25 mA

Po: 60 mW

Lo: 33 mH

Co: 2,4 $\mu\text{F}$

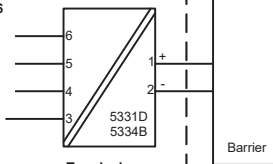

**Terminais:**

**1,2**

Ui: 30 VDC

Ii: 120 mA

Pi: 0,84 W

Li: 10 $\mu\text{H}$

Ci: 1,0nF

**Notas de instalação**

O circuito do sensor não é isolado galvanicamente do circuito de entrada de forma infalível. Contudo, a isolamento galvânica entre os circuitos é capaz de resistir a um ensaio de tensão de 500Vac durante 1 minuto.

Em uma atmosfera de gás potencialmente explosiva, o transmissor deve ser montado em um invólucro a fim de garantir um grau de proteção de no mínimo IP20 de acordo com a ABNT NBR IEC60529. Se contudo, o ambiente necessitar de um nível de proteção maior, isso deve ser levado em consideração.

Se o transmissor é instalado em uma atmosfera explosiva exigindo o uso de equipamento de proteção de nível Ga e se o invólucro é feito de alumínio, ele deve ser instalado de modo que, mesmo em caso remoto de avaria, fontes de ignição devido ao impacto e fricção, faíscas são eliminadas.

Se o invólucro é feito de materiais não metálicos, cargas eletrostáticas devem ser evitadas.

Para instalação em atmosfera de poeira potencialmente explosiva, as instruções a seguir são aplicáveis:

O transmissor deve ser montado em invólucro de metal forma B de acordo com DIN43729 que está fornecendo um grau de proteção de pelo menos IP6X de acordo com ABNT NBR IEC60529. O invólucro deve ser adequado para aplicação pretendida e instalado corretamente.

As entradas dos cabos e os elementos de obturação que podem ser utilizados devem ser adequados à aplicação pretendida e corretamente instalados.

Para temperatura ambiente  $\geq 60^{\circ}\text{C}$ , fios de resistência ao calor devem ser usados com uma faixa de pelo menos 20K acima da temperatura ambiente.

A temperatura da superfície do invólucro é igual à temperatura ambiente mais 20 K, por uma camada de pó, com espessura de até 5 mm.



**Индикаторы** Программируемые дисплеи с большим выбором вводов и выводов для индикации температуры, объема, веса и т. д. Обеспечивают линейризацию и масштабирование сигналов, имеют ряд измерительных функций, программируемых при помощи ПО PReset.



**Ex-барьеры** Интерфейсы для аналоговых и цифровых сигналов и сигналов HART® между датчиками / преобразователями I/P / сигналами частоты и СУ в опасных зонах Ex 0, 1 и 2, ряд модулей - в опасных зонах 20, 21 и 22.



**Развязка** Устройства гальванической развязки аналоговых и цифровых сигналов, а также сигналов в протоколе HART®. Обширная программа модулей с питанием от токовой петли или универсальным, для линейризации, инвертирования и масштабирования выходных сигналов.























**Температура** Широкий выбор температурных преобразователей для монтажа в корпусе датчика стандарта DIN типа В и для установки на DIN-рейке, с обменом аналоговых и цифровых данных по шине. Предлагаются как под конкретные применения, так и универсальные.



**Универсальность** Программируемые с ПК или с панели модули с универсальным рядом вводов, выводов и питания. Модули этого ряда имеют функции высокого порядка, напр. калибровка процесса, линейризация и самодиагностика.



-   [www.preelectronics.fr](http://www.preelectronics.fr)  
 [sales-fr@preelectronics.com](mailto:sales-fr@preelectronics.com)
-   [www.preelectronics.de](http://www.preelectronics.de)  
 [sales-de@preelectronics.com](mailto:sales-de@preelectronics.com)
-   [www.preelectronics.es](http://www.preelectronics.es)  
 [sales-es@preelectronics.com](mailto:sales-es@preelectronics.com)
-   [www.preelectronics.it](http://www.preelectronics.it)  
 [sales-it@preelectronics.com](mailto:sales-it@preelectronics.com)
-   [www.preelectronics.se](http://www.preelectronics.se)  
 [sales-se@preelectronics.com](mailto:sales-se@preelectronics.com)
-   [www.preelectronics.com](http://www.preelectronics.com)  
 [sales-uk@preelectronics.com](mailto:sales-uk@preelectronics.com)
-   [www.preelectronics.com](http://www.preelectronics.com)  
 [sales-us@preelectronics.com](mailto:sales-us@preelectronics.com)
-   [www.preelectronics.cn](http://www.preelectronics.cn)  
 [sales-cn@preelectronics.com](mailto:sales-cn@preelectronics.com)

## Головной офис

---

Denmark - Дания  
PR electronics A/S  
Lerbakken 10  
DK-8410 Rønde

[www.preelectronics.com](http://www.preelectronics.com)  
[sales@preelectronics.dk](mailto:sales@preelectronics.dk)  
тел. +45 86 37 26 77  
факс +45 86 37 30 85